

# LINEA SPILLATORI REFRIGERATI PER BAG-IN-BOX

## REFRIGERATED DISPENSER FOR BAG-IN-BOX

# TOTEM

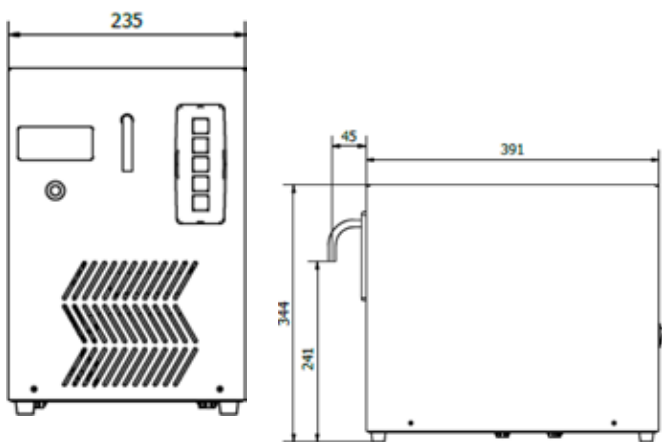

### Descrizione Prodotto











#### Item Description

Wine dispenser che utilizza BIB di vino da 3, 5, 10 litri e sacche pouch up da 1,5 - 3 litri; anche per succhi di frutta, tea, caffè, acqua, cocktail. Refrigerazione istantanea, erogazione programmabile con 4 dosi differenziate, precisa e senza sgocciolamento, nessuna installazione necessaria, collegamento alla corrente elettrica, assenza di manutenzione, assenza del processo di ossidazione.

*Wine refrigerated BIB dispenser for 3, 5, 10 litres bibs; for wine, juice, tea, coffee, water, cocktail and more. Instant refrigeration, automatic pour measuring: 4 custom preset, no installation required, plug-in appliance, no maintenance required, no oxidation process.*

### Caratteristiche Tecniche

#### Technical Specification

	<b>Variabile / Variable</b> +6° / +18°		<b>Manuale</b> Manual
TEMPERATURA / TEMPERATURE °C		SBRINAMENTO / DEFROST	
		Con coperchio in legno With wooden lid	
		235x436x580 (LxPxA)	
		Senza coperchio in legno Without wooden lid	
		235x436x344 (LxPxA)	
	<b>Plug-In</b>		DIMENSIONI / DIMENSIONS (mm)
INSTALLAZIONE / INSTALLATION			Con coperchio in legno With wooden lid 17
	<b>R600a</b>		Senza coperchio in legno Without wooden lid 15
GAS		PESO / WEIGHT (kg)	
	<b>N. D.</b>		<b>BIB 3, 5, 10 Lt.</b>
ILLUMINAZIONE / LIGHTING		VOLUME VASCA / TANK VOLUME (lt.)	
	<b>Elettronico</b> Electronic		-
THERMOSTATO / THERMOSTAT		CLASSE ENERGETICA / ENERGY RATING	